

Overview



SITRANS LC300 is an inverse frequency shift capacitance continuous level transmitter for liquid, interface, and solid applications. It is ideal for standard industrial applications in chemical, hydrocarbon processing, food and beverage, water, wastewater, mining, aggregate, and cement industries.

Benefits

- Active-Shield technology so measurement is unaffected by material buildup in active shield section
- Highly accurate and reliable PFA-lined probes
- Integrated local LCD display
- 2-wire (4 to 20 mA) current loop design
- Current signaling according to NAMUR NE 43
- Push-button calibration and programming
- Stilling well (ground tube) version for low dielectric media, agitated materials, and non-metallic vessels

Application

SITRANS LC300 is a 2-wire level measurement instrument combining a sophisticated, yet easy-to-adjust microprocessor with field-proven probes. It is available in four versions: rod, rod with stilling well, cable with PFA insulation, and cable without PFA insulation. Materials with low or high dielectric properties are accurately measured and Active-Shield technology helps in ignoring the effects of buildup or condensation near vessel nozzle.

- Key Applications: conductive ($dK \geq 20$) and non-conductive ($dK < 20$) media including: liquids and solids in standard industrial processes, bulk solids applications involving dust, and chemical processes involving vapor

Probe Applications

Rod version	Conductive liquids, slurries or solids
Rod version with stilling well	<ul style="list-style-type: none"> • Conductive liquids or slurries in non-conductive tanks • Non-conductive liquids in non-conductive tanks • Tanks with agitation or turbulent liquids • Liquids with a dielectric constant below 2 • Non-linear tanks, such as parabolic or spherical tanks • Interface measurements
Cable version	Non-conductive solids or liquids
PFA coated cable version	Conductive or sticky liquids, slurries or solids

Configuration

Installation

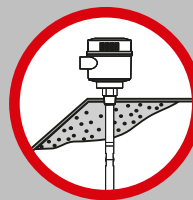

Build up of material in active shield area does not affect switch operation.

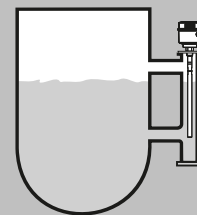

Mounting on a bypass

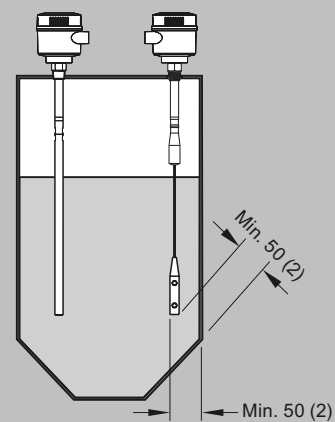

Install probe at least 50 (2) from tank wall. Note angle of repose and adjust accordingly.

SITRANS LC300 installation, dimensions in mm (inch)

SITRANS LC300

Selection and ordering data

SITRANS LC300 Capacitance level transmitter, rod design Continuous, contact, monitors level or interface in liquids or solids. Extension options up to 5 m (16.40 ft).		Article No. 7ML560- ● ● ● ● ● - ● ● ● ● 0									
Click on the Article No. for the online configuration in the PIA Life Cycle Portal.											
Process connection											
Threaded, 316L stainless steel											
¾" NPT [(Taper), ASME B1.20.1]	0	A									
1" NPT [(Taper), ASME B1.20.1]	0	B									
1¼" NPT [(Taper), ASME B1.20.1]	0	C									
1½" NPT [(Taper), ASME B1.20.1]	0	D									
R ¾" [(BSPT), EN 10226/PT (JIS-T), JIS B 0203]	1	A									
R 1" [(BSPT), EN 10226/PT (JIS-T), JIS B 0203]	1	B									
R 1½" [(BSPT), EN 10226/PT (JIS-T), JIS B 0203]	1	D									
G ¾" [(BSPP), EN ISO 228-1/PF (JIS-P), JIS B 0202]	3	A									
G 1" [(BSPP), EN ISO 228-1/PF (JIS-P), JIS B 0202]	3	B									
G 1½" [(BSPP), EN ISO 228-1/PF (JIS-P), JIS B 0202]	3	D									
Welded flange, 316L stainless steel, raised face ¹⁾											
1" ASME, 150 lb	5	A									
1" ASME, 300 lb	5	B									
1" ASME, 600 lb	5	C									
1½" ASME, 150 lb	5	D									
1½" ASME, 300 lb	5	E									
1½" ASME, 600 lb	5	F									
2" ASME, 150 lb	5	G									
2" ASME, 300 lb	5	H									
2" ASME, 600 lb	5	J									
3" ASME, 150 lb	5	K									
3" ASME, 300 lb	5	L									
3" ASME, 600 lb	5	M									
4" ASME, 150 lb	5	N									
4" ASME, 300 lb	5	P									
4" ASME, 600 lb	5	Q									
Welded flange, 316L stainless steel, Type A flat faced ¹⁾											
DN 25, PN 16	6	A									
DN 25, PN 40	6	B									
DN 40, PN 16	6	C									
DN 40, PN 40	6	D									
DN 50, PN 16	6	E									
DN 50, PN 40	6	F									
DN 80, PN 16	6	G									
DN 80, PN 40	6	H									
DN 100, PN 16	6	J									
DN 100, PN 40	6	K									
Sanitary, hastelloy, duplex or other custom process connections available. Please contact a local sales person for details. For more information, please visit http://www.automation.siemens.com/aspa_app .											
Probe Length (from flange face or including process thread)											
Add Order code Y01 and plain text: "Insertion length ... mm"											
300 ... 1 000 mm (11.81 ... 39.37 inch)		A									
1 001 ... 2 000 mm (39.41 ... 78.74 inch)		B									
2 001 ... 3 000 mm (78.78 ... 118.11 inch)		C									
3 001 ... 4 000 mm (118.15 ... 157.48 inch)		D									
4 001 ... 5 000 mm (157.52 ... 196.85 inch)		E									
Bent probes also available. Please contact a local sales person for details. For more information, please visit http://www.automation.siemens.com/aspa_app .											
Thermal isolator											
Without thermal isolator								0			
With thermal isolator [for process connection temperatures over 85 °C (185 °F)]								1			
Wetted seals											
FKM									0		

Selection and ordering data (continued)

		Article No.										
SITRANS LC300 Capacitance level transmitter, rod design Continuous, contact, monitors level or interface in liquids or solids. Extension options up to 5 m (16.40 ft).		7	M	L	5	6	0	-	0	0	0	0
FFKM [for process temperatures above -20 °C (4 °F) ²⁾									1			
Probe material												
19 mm (0.75 inch) diameter 316L stainless steel, PFA lined rod											0	
Approvals												
General Safety (CSA, FM, CE, RCM)												A
Dust Ignition Proof With IS Probe CE, RCM, ATEX II 1/2 D T100 °C												B
Flame Proof Enclosure With IS Probe CE, RCM, ATEX II 1/2 G EEx d [ia] IIC T6 ... T1, ATEX II 1/2 D T100 °C												C
Dust Ignition Proof With IS Probe CSA/FM Class II, Div. 1, Groups E, F, G CSA/FM Class III T4												D
Explosion Proof Enclosure With IS Probe CSA/FM Class I, Div. 1, Groups A, B, C, D CSA/FM Class II, Div. 1, Groups E, F, G CSA/FM Class III T4												E
Enclosure												
Aluminum epoxy coated 2 x 1/2" NPT via adapter - cable inlet, IP65												A
Aluminum epoxy coated 2 x M20 x 1.5 cable inlet, IP65												B
Aluminum epoxy coated 2 x 1/2" NPT via adapter - cable inlet, IP68												C
Aluminum epoxy coated 2 x M20 x 1.5 cable inlet, IP68												D
Stainless steel, contact local sales person for details. For more information, please visit http://www.automation.siemens.com/aspa_app .												

¹⁾ Flange bolting patterns and facings dimensionally correspond to the applicable ASME B16.5 or EN 1092-1 standard.

²⁾ Not available with FM approvals.

Selection and Ordering data	Order code
Further designs	
Please add "-Z" to Article No. and specify Order code(s).	
Insertion length, specify in plain text: Y01: ... mm	Y01
Stainless steel tag [70 x 13 mm (2.75 x 0.5 inch)]: Measuring-point number/identification (max. 27 characters) specify in plain text	Y15
Manufacturer's Test Certificate: M to DIN 55350, Part 18 and to ISO 9000	C11
Material inspection Certificate Type 3.1 per EN 10204	C12
INMETRO ¹⁾	E34

Accessories	Article No.
Operating Instructions	
All literature is available to download for free, in a range of languages, at http://www.siemens.com/processinstrumentation/documentation	
Accessories	
Electronic transmitter kit (includes transmitter and driver)	7ML1830-1KN
SITRANS RD100, loop powered display - see Chapter 7	7ML5741-.....
SITRANS RD150, remote digital display for 4 ... 20 mA and HART devices - see Chapter 7	7ML5742-.....
SITRANS RD200, universal input display with Modbus conversion - see Chapter 7	7ML5740-.....
SITRANS RD300, dual line display with totalizer and linearization curve and Modbus conversion - see Chapter 7	7ML5744-.....
For applicable back up point level switch - see point level measurement section	

¹⁾ Available only with Approvals options A and B.

SITRANS LC300

Selection and ordering data (continued)

SITRANS LC300 Capacitance level transmitter, stilling well design		Article No.									
Continuous, contact, monitors level or interface in liquids. Extension options up to 5 m (16.40 ft).		7ML5671- ● ● ● ● ● - ● ● ● ● 0									
Click on the Article No. for the online configuration in the PIA Life Cycle Portal.											
Process connection											
Threaded, 316L stainless steel											
1½" NPT [(Taper), ASME B1.20.1]	0	D									
R 1½" [(BSPT), EN 10226/PT (JIS-T), JIS B 0203]	1	D									
G 1½" [(BSPP), EN ISO 228-1/PF (JIS-P), JIS B 0202]	3	D									
<u>Welded flange, 316L stainless steel, raised face ¹⁾</u>											
1½" ASME, 150 lb	5	D									
1½" ASME, 300 lb	5	E									
1½" ASME, 600 lb	5	F									
2" ASME, 150 lb	5	G									
2" ASME, 300 lb	5	H									
2" ASME, 600 lb	5	J									
3" ASME, 150 lb	5	K									
3" ASME, 300 lb	5	L									
3" ASME, 600 lb	5	M									
4" ASME, 150 lb	5	N									
4" ASME, 300 lb	5	P									
4" ASME, 600 lb	5	Q									
<u>Welded flange, 316L stainless steel, Type A flat faced ¹⁾</u>											
DN 40, PN 16	6	C									
DN 40, PN 40	6	D									
DN 50, PN 16	6	E									
DN 50, PN 40	6	F									
DN 80, PN 16	6	G									
DN 80, PN 40	6	H									
DN 100, PN 16	6	J									
DN 100, PN 40	6	K									
Sanitary, hastelloy, duplex or other custom process connections available. Please contact a local sales person for details. For more information, please visit http://www.automation.siemens.com/aspa_app .											
Probe Length (from flange face or including process thread)											
Add Order code Y01 and plain text: "Insertion length ... mm"											
300 ... 1 000 mm (11.81 ... 39.37 inch)										A	
1 001 ... 2 000 mm (39.41 ... 78.74 inch)										B	
2 001 ... 3 000 mm (78.78 ... 118.11 inch)										C	
3 001 ... 4 000 mm (118.15 ... 157.48 inch)										D	
4 001 ... 5 000 mm (157.52 ... 196.85 inch)										E	
Thermal isolator											
Without thermal isolator								0			
With thermal isolator [for process connection temperatures over 85 °C (185 °F)]								1			
Wetted seals											
FKM								0			
FFKM [for process temperatures above -20 °C (4 °F)] ²⁾								1			
Probe material											
35 mm (1.38 inch) diameter stilling well, with 19 mm (0.75 inch) diameter 316L stainless steel, PFA lined rod with PTFE spacers										1	
Approvals											
General Safety (CSA, FM, CE, RCM)											A
Dust Ignition Proof With IS Probe CE, RCM, ATEX II 1/2 D T100 °C											B
Flame Proof Enclosure With IS Probe CE, RCM, ATEX II 1/2 G EEx d [ia] IIC T6 ... T1, ATEX II 1/2 D T100 °C											C
Dust Ignition Proof With IS Probe CSA/FM Class II, Div. 1, Groups E, F, G CSA/FM Class III T4											D

Selection and ordering data (continued)

SITRANS LC300 Capacitance level transmitter, stilling well design									
Continuous, contact, monitors level or interface in liquids. Extension options up to 5 m (16.40 ft).									
Article No. 7ML5671- ● ● ● ● ● - ● ● ● 0									
Explosion Proof Enclosure With IS Probe CSA/FM Class I, Div. 1, Groups A, B, C, D CSA/FM Class II, Div. 1, Groups E, F, G CSA/FM Class III T4									
Enclosure									
Aluminum epoxy coated 2 x ½" NPT via adapter - cable inlet, IP65									
Aluminum epoxy coated 2 x M20 x 1.5 cable inlet, IP65									
Aluminum epoxy coated 2 x ½" NPT via adapter - cable inlet, IP68									
Aluminum epoxy coated 2 x M20 x 1.5 cable inlet, IP68									
Stainless steel, please contact a local sales person for details. For more information, please visit http://www.automation.siemens.com/aspa_app .									

- 1) Flange bolting patterns and facings dimensionally correspond to the -applicable ASME B16.5 or EN 1092-1 standard.
2) Not available with FM approvals.

Selection and Ordering data	Order code
Further designs	
Please add "-Z" to Article No. and specify Order code(s).	
Insertion length, specify in plain text: Y01: ... mm	Y01
Stainless steel tag [70 x 13 mm (2.75 x 0.5 inch)]: Measuring-point number/identification (max. 27 characters) specify in plain text	Y15
Manufacturer's Test Certificate: M to DIN 55350, Part 18 and to ISO 9000	C11
Material inspection Certificate Type 3.1 per EN 10204 INMMETRO ¹⁾	C12 E34

Accessories	Article No.
Operating Instructions	
All literature is available to download for free, in a range of languages, at http://www.siemens.com/processinstrumentation/documentation	
Accessories	
Electronic transmitter kit (includes transmitter and driver)	7ML1830-1KN
SITRANS RD100, loop powered display - see Chapter 7	7ML5741-.....
SITRANS RD150, remote digital display for 4 ... 20 mA and HART devices - see Chapter 7	7ML5742-.....
SITRANS RD200, universal input display with Modbus conversion - see Chapter 7	7ML5740-.....
SITRANS RD300, dual line display with totalizer and linearization curve and Modbus conversion - see Chapter 7	7ML5744-.....
For applicable back up point level switch - see point level measurement section	

- 1) Available only with Approvals options A and B.

SITRANS LC300 Capacitance level transmitter, cable design									
Continuous, contact, monitors level or interface in liquids or solids. Extension options up to 25 m (82.02 ft).									
Article No. 7ML5672- ● ● ● ● ● - ● ● ● 0									
Click on the Article No. for the online configuration in the PIA Life Cycle Portal.									
Process connection									
Threaded, 316L stainless steel									
1½" NPT [(Taper), ASME B1.20.1]									
R 1½" [(BSPT), EN 10226/PT (JIS-T), JIS B 0203]									
G 1½" [(BSPP), EN ISO 228-1/PF (JIS-P), JIS B 0202]									

SITRANS LC300

Selection and ordering data (continued)

SITRANS LC300 Capacitance level transmitter, cable design Continuous, contact, monitors level or interface in liquids or solids. Extension options up to 25 m (82.02 ft).	Article No. 7ML5672- ● ● ● ● ● - ● ● ● ● 0									
Welded flange, 316L stainless steel, raised face ¹⁾										
1½" ASME, 150 lb	5	D								
1½" ASME, 300 lb	5	E								
1½" ASME, 600 lb	5	F								
2" ASME, 150 lb	5	G								
2" ASME, 300 lb	5	H								
2" ASME, 600 lb	5	J								
3" ASME, 150 lb	5	K								
3" ASME, 300 lb	5	L								
3" ASME, 600 lb	5	M								
4" ASME, 150 lb	5	N								
4" ASME, 300 lb	5	P								
4" ASME, 600 lb	5	Q								
Welded flange, 316L stainless steel, Type A flat faced ¹⁾										
DN 40, PN 16	6	C								
DN 40, PN 40	6	D								
DN 50, PN 16	6	E								
DN 50, PN 40	6	F								
DN 80, PN 16	6	G								
DN 80, PN 40	6	H								
DN 100, PN 16	6	J								
DN 100, PN 40	6	K								
Sanitary, hastelloy, duplex or other custom process connections available. Please contact a local sales person for details. For more information, please visit http://www.automation.siemens.com/aspa_app .										
Probe Length (from flange face or including process thread)										
Add Order code Y01 and plain text: "Insertion length ... mm"										
1 000 ... 2 000 mm (39.37 ... 78.74 inch)									A	
2 001 ... 4 000 mm (78.78 ... 157.48 inch)									B	
4 001 ... 6 000 mm (157.52 ... 236.22 inch)									C	
6 001 ... 8 000 mm (236.26 ... 314.96 inch)									D	
8 001 ... 10 000 mm (315.00 ... 393.70 inch)									E	
8 001 ... 10 000 mm (315.00 ... 393.70 inch)									F	
12 001 ... 14 000 mm (472.48 ... 551.18 inch)									G	
14 001 ... 16 000 mm (551.22 ... 629.92 inch) ²⁾									H	
16 001 ... 18 000 mm (629.96 ... 708.66 inch) ²⁾									J	
18 001 ... 20 000 mm (708.70 ... 787.40 inch) ²⁾									K	
20 001 ... 22 000 mm (787.44 ... 866.14 inch) ²⁾									L	
22 001 ... 24 000 mm (866.18 ... 944.88 inch) ²⁾									M	
24 001 ... 25 000 mm (944.92 ... 984.25 inch) ²⁾									N	
Thermal isolator										
Without thermal isolator								0		
With thermal isolator [for process connection temperatures over 85 °C (185 °F)]								1		
Wetted seals										
FKM								0		
FFKM [for process temperatures above -20 °C (4 °F)] ³⁾								1		
Probe material										
Bare 316L stainless steel cable and 316L stainless steel cable weight, tinned copper crimp, PTFE backing ring, PEEK isolator and PFA lined active shield								0		
Approvals										
General Safety (CSA, FM, CE, RCM)										A
Dust Ignition Proof With IS Probe CE, RCM, ATEX II 1/2 D T100 °C										B
Flame Proof Enclosure With IS Probe CE, RCM, ATEX II 1/2 G EEx d [ia] IIC T6 ... T1, ATEX II 1/2 D T100 °C										C
Dust Ignition Proof With IS Probe CSA/FM Class II, Div. 1, Groups E, F, G CSA/FM Class III T4										D

Selection and ordering data (continued)

		Article No.									
SITRANS LC300 Capacitance level transmitter, cable design Continuous, contact, monitors level or interface in liquids or solids. Extension options up to 25 m (82.02 ft).		7	M	L	5	6	7	2	-	0	0
Explosion Proof Enclosure With IS Probe CSA/FM Class I, Div. 1, Groups A, B, C, D CSA/FM Class II, Div. 1, Groups E, F, G CSA/FM Class III T4										E	
Enclosure											
Aluminum epoxy coated 2 x ½" NPT via adapter - cable inlet, IP65											A
Aluminum epoxy coated 2 x M20 x 1.5 cable inlet, IP65											B
Aluminum epoxy coated 2 x ½" NPT via adapter - cable inlet, IP68											C
Aluminum epoxy coated 2 x M20 x 1.5 cable inlet, IP68											D
Stainless steel, please contact a local sales person for details. For more information, please visit http://www.automation.siemens.com/aspa_app .											

¹⁾ Flange bolting patterns and facings dimensionally correspond to the applicable ASME B16.5 or EN 1092-1 standard.

²⁾ Cable lengths from 15 000 mm (590.55 inch) to 25 000 mm (984.25 inch) can be used in non-conductive media. Contact Factory for assistance.

³⁾ Not available with FM approvals.

Selection and Ordering data	Order code
Further designs	
Please add "-Z" to Article No. and specify Order code(s).	
Insertion length, specify in plain text: Y01: ... mm	Y01
Stainless steel tag [70 x 13 mm (2.75 x 0.5 inch)]: Measuring-point number/identification (max. 27 characters) specify in plain text	Y15
Manufacturer's Test Certificate: M to DIN 55350, Part 18 and to ISO 9000	C11
Material inspection Certificate Type 3.1 per EN 10204 INMETRO ¹⁾	C12 E34

Accessories	Article No.
Operating Instructions	
All literature is available to download for free, in a range of languages, at http://www.siemens.com/processinstrumentation/documentation	
Accessories	
Electronic transmitter kit (includes transmitter and driver)	7ML1830-1KN
SITRANS RD100, loop powered display - see Chapter 7	7ML5741-.....
SITRANS RD150, remote digital display for 4 ... 20 mA and HART devices - see Chapter 7	7ML5742-.....
SITRANS RD200, universal input display with Modbus conversion - see Chapter 7	7ML5740-.....
SITRANS RD300, dual line display with totalizer and linearization curve and Modbus conversion - see Chapter 7	7ML5744-.....
For applicable back up point level switch - see point level measurement section	

¹⁾ Available only with Approvals options A and B.

		Article No.									
SITRANS LC300 Capacitance level transmitter, PFA coated cable design Continuous, contact, monitors level or interface in liquids or solids. Extension options up to 25 m (82.02 ft).		7	M	L	5	6	7	3	-	0	0
Click on the Article No. for the online configuration in the PIA Life Cycle Portal.											
Process connection											
Threaded, 316L stainless steel											
1½" NPT [(Taper), ASME B1.20.1]		0									D
R 1½" [(BSPT), EN 10226/PT (JIS-T), JIS B 0203]		1									D
G 1½" [(BSPP), EN ISO 228-1/PF (JIS-P), JIS B 0202]		3									D

SITRANS LC300

Selection and ordering data (continued)

SITRANS LC300 Capacitance level transmitter, PFA coated cable design		Article No.									
Continuous, contact, monitors level or interface in liquids or solids. Extension options up to 25 m (82.02 ft).		7ML5673- ● ● ● ● ● - ● ● ● ●									
<u>Welded flange, 316L stainless steel, raised face</u> ¹⁾											
1½" ASME, 150 lb		5	D								
1½" ASME, 300 lb		5	E								
1½" ASME, 600 lb		5	F								
2" ASME, 150 lb		5	G								
2" ASME, 300 lb		5	H								
2" ASME, 600 lb		5	J								
3" ASME, 150 lb		5	K								
3" ASME, 300 lb		5	L								
3" ASME, 600 lb		5	M								
4" ASME, 150 lb		5	N								
4" ASME, 300 lb		5	P								
4" ASME, 600 lb		5	Q								
<u>Welded flange, 316L stainless steel, Type A flat faced</u> ¹⁾											
DN 40, PN 16		6	C								
DN 40, PN 40		6	D								
DN 50, PN 16		6	E								
DN 50, PN 40		6	F								
DN 80, PN 16		6	G								
DN 80, PN 40		6	H								
DN 100, PN 16		6	J								
DN 100, PN 40		6	K								
Sanitary, hastelloy, duplex or other custom process connections available. Please contact a local sales person for details. For more information, please visit http://www.automation.siemens.com/aspa_app .											
Probe Length (from flange face or including process thread)											
Add Order code Y01 and plain text: "Insertion length ... mm"											
1 000 ... 2 000 mm (39.37 ... 78.74 inch)										A	
2 001 ... 4 000 mm (78.78 ... 157.48 inch)										B	
4 001 ... 6 000 mm (157.52 ... 236.22 inch)										C	
6 001 ... 8 000 mm (236.26 ... 314.96 inch)										D	
8 001 ... 10 000 mm (315.00 ... 393.70 inch)										E	
10 001 ... 12 000 mm (393.74 ... 472.44 inch)										F	
12 001 ... 14 000 mm (472.48 ... 551.18 inch)										G	
14 001 ... 16 000 mm (551.22 ... 629.92 inch) ²⁾										H	
16 001 ... 18 000 mm (629.96 ... 708.66 inch) ²⁾										J	
18 001 ... 20 000 mm (708.70 ... 787.40 inch) ²⁾										K	
20 001 ... 22 000 mm (787.44 ... 866.14 inch) ²⁾										L	
22 001 ... 24 000 mm (866.18 ... 944.88 inch) ²⁾										M	
24 001 ... 25 000 mm (944.92 ... 984.25 inch) ²⁾										N	
Thermal isolator											
Without thermal isolator									0		
With thermal isolator [for process connection temperatures over 85 °C (185 °F)]									1		
Wetted seals											
FKM									0		
FFKM [for process temperatures above -20 °C (-4 °F)] ³⁾									1		
Probe material											
PFA coated cable and 316L stainless steel cable weight, PEEK isolator and PFA lined active shield										1	
Approvals											
General Safety (CSA, FM, CE, RCM)											A
Dust Ignition Proof With IS Probe CE, RCM, ATEX II 1/2 D T100 °C											B
Flame Proof Enclosure With IS Probe CE, RCM, ATEX II 1/2 G EEx d [ia] IIC T6 ... T1, ATEX II 1/2 D T100 °C											C
Dust Ignition Proof With IS Probe CSA/FM Class II, Div. 1, Groups E, F, G CSA/FM Class III T4											D

Selection and ordering data (continued)

	Article No.
SITRANS LC300 Capacitance level transmitter, PFA coated cable design	7ML5673- ● ● ● ● ● - ● ● ● ●
Continuous, contact, monitors level or interface in liquids or solids. Extension options up to 25 m (82.02 ft).	
Explosion Proof Enclosure With IS Probe CSA/FM Class I, Div. 1, Groups A, B, C, D CSA/FM Class II, Div. 1, Groups E, F, G CSA/FM Class III T4	E
Enclosure	
Aluminum epoxy coated 2 x 1/2" NPT via adapter - cable inlet, IP65	A
Aluminum epoxy coated 2 x M20 x 1.5 cable inlet, IP65	B
Aluminum epoxy coated 2 x 1/2" NPT via adapter - cable inlet, IP68	C
Aluminum epoxy coated 2 x M20 x 1.5 cable inlet, IP68	D
Stainless steel, please contact a local sales person for details. For more information, please visit http://www.automation.siemens.com/aspa_app .	
Mounting eye	
Without Mounting eye	0
With mounting eye	1

¹⁾ Flange bolting patterns and facings dimensionally correspond to the -applicable ASME B16.5 or EN 1092-1 standard.

²⁾ Cable lengths from 15 000 mm (590.55 inch) to 25 000 mm (984.25 inch) can be used in non-conductive media. Contact Factory for assistance.

³⁾ Not available with FM approvals.

Selection and Ordering data	Order code
Further designs	
Please add "-Z" to Article No. and specify Order code(s).	
Insertion length, specify in plain text: Y01: ... mm	Y01
Stainless steel tag [70 x 13 mm (2.75 x 0.5 inch)]: Measuring-point number/identification (max. 27 characters) specify in plain text	Y15
Manufacturer's Test Certificate: M to DIN 55350, Part 18 and to ISO 9000	C11
Material inspection Certificate Type 3.1 per EN 10204	C12
INMETRO ¹⁾	E34

Accessories	Article No.
Operating Instructions	
All literature is available to download for free, in a range of languages, at http://www.siemens.com/processinstrumentation/documentation	
Accessories	
Electronic transmitter kit (includes transmitter and driver)	7ML1830-1KN
SITRANS RD100, loop powered display - see Chapter 7	7ML5741-.....
SITRANS RD150, remote digital display for 4 ... 20 mA and HART devices - see Chapter 7	7ML5742-.....
SITRANS RD200, universal input display with Modbus conversion - see Chapter 7	7ML5740-.....
SITRANS RD300, dual line display with totalizer and linearization curve and Modbus conversion - see Chapter 7	7ML5744-.....
For applicable back up point level switch - see point level measurement section	

¹⁾ Available only with Approvals options A and B.

LC300 Specials ¹⁾	
LC300 Cable Extensions, 316L stainless steel	
Kit, Stainless steel cable extension, 1 m, adjustable by customer	A5E01163688
Kit, Stainless steel cable extension, 3 m, adjustable by customer	A5E01163689
Kit, Stainless steel cable extension, 5 m, adjustable by customer	A5E01163690
Kit, Stainless steel cable extension, 10 m, adjustable by customer	A5E01163691

SITRANS LC300

Selection and ordering data (continued)

LC300 Specials ¹⁾	
Kit, Stainless steel cable extension, 15 m, adjustable by customer	A5E01163693
Kit, Stainless steel cable extension, 20 m, adjustable by customer	A5E01163695
LC300 Cable Extensions, 316 stainless steel with PFA coating	
Kit, PFA cable extension, 1 m	A5E01163709
Kit, PFA cable extension, 3 m	A5E01163710
Kit, PFA cable extension, 5 m	A5E01163711
Kit, PFA cable extension, 10 m	A5E01163712
Kit, PFA cable extension, 15 m	A5E01163713
Kit, PFA cable extension, 20 m	A5E01163714
LC300 Mounting Eye	
Spare mounting eye (LC300 PFA versions only)	A5E01163717
LC300 Weight Kit, 316L stainless steel	
Kit, Spare stainless steel weight. To be used in any cable version of CLS300, or stainless steel cable version of LC300	A5E01163727

Customers interested in a custom designed device should consult a local sales person. For more information, please visit http://www.automation.siemens.com/aspa_app.

Technical specifications

SITRANS LC300	
Input	
Measuring range	1.66 ... 3 300 pF
Span	Min. 3.3 pF
Output	
Loop current	Continuous signal 4 ... 20 mA/20 ... 4 mA according to NAMUR 43
Accuracy (transmitter)	
Temperature stability	0.25 % of actual capacitance value
Non-linearity and repeatability	< 0.4 % of full scale and actual measurement value
Accuracy	Deviation < 0.5 % of actual measurement value
Rated operating conditions¹⁾	
Ambient conditions	
• Ambient temperature	-40 ... +85 °C (-40 ... +185 °F) ²⁾³⁾
• Storage temperature	-40 ... +85 °C (-40 ... +185 °F)
• Installation category	I
• Pollution degree	4
• Ingress protection	Type 4/NEMA 4/IP65 (optional IP68)
Installation conditions	
• Location	Indoor/outdoor
• Process pressure	-1 ... +35 bar g (-14.6 ... +511 psi g)
• Process temperature	-40 ... +200 °C (-40 ... +392 °F) ⁴⁾
• Min. dielectric constant ϵ_r	1.5
• Min. difference in dielectric constant for interface measurement	5
Design	
Material	
• Enclosure	Aluminum, epoxy-coated
Probe diameter	
• Rod version	19 mm (0.75 inch) with PFA jacket
• Cable version	9 mm (0.35 inch) with PFA jacket, 6 mm (0.24 inch) without PFA jacket
Active shield length	
• Rod version	Threaded: 120 mm (4.72 inch) Flanged: 100 mm (3.94 inch)
• Cable version	Threaded: 125 mm (4.92 inch) Flanged: 105 mm (4.13 inch)
Process connection of probe	

Technical specifications (continued)

SITRANS LC300	
• Threaded rod mounting	3/4", 1", 1 1/4", 1 1/2" NPT [(Taper), ANSI/ASME B1.20.1] R 3/4", 1", 1 1/2" [(BSPT), EN 10226/PT (JIS-T), JIS B 0203] G 3/4", 1", 1 1/2" [(BSPP), EN ISO 228-1/PF (JIS-P), JIS B 0202]
• Threaded cable mounting	1 1/2" NPT [(Taper), ANSI/ASME B1.20.1] R 1 1/2" [(BSPT), EN 10226/PT (JIS-T), JIS B 0203] G 1 1/2" [(BSPP), EN ISO 228-1/PF (JIS-P), JIS B 0202]
• Flange mounting	1 ... 4" ASME, DN 25 ... 100
Enclosure cable inlet	2 x 1/2" NPT or 2 x M20 x 1.5
Power supply	12 ... 30 V DC any polarity, 2-wire current loop circuit
User Interface	
Display	Local LCD, 4 digit, each 0 ... 9 and limited alpha characters
Safety	
Measurement current signaling	According to NAMUR NE 43, signal 3.8 ... 20.5 mA, fault ≤ 3.6 or ≥ 21 mA (22 mA)
Certificates and approvals	
General	CE, CSA _{US/IC} , FM, RCM, KCC, EAC
Dust Ignition Proof (Intrinsically Safe probe circuit)	
• Canada/USA	FM/CSA: Class II, Div. 1, Groups E, F, G Class III T4
• Europe	ATEX 1/2 D T100 °C
Flame Proof (Intrinsically Safe probe circuit)	
• Europe	ATEX II 1/2 G EEx d [ia] IIC T6 ... T1 ATEX II 1/2 D T100 °C
• Brazil	Ex d [ia Ga] IIC T6 ... T4 Gb Ex tb IIIC T85 °C ... T100 °C Db IP65/IP68
• Russia/Kazakhstan	EAC Ex
Explosion Proof (Intrinsically Safe probe circuit)	
• Canada/USA	Class I, Div. 1, Groups A, B, C, D Class II, Div. 1, Groups E, F, G Class III T4
Marine	ABS Type Approval, Lloyds Register
Overfill Protection	VLAREM II
Other	Pattern Approval (AQSIQ, China), CRN, PED

¹⁾ When operation is in areas classified as hazardous, observe restrictions according to relevant certificate. See also LC300 Pressure/Temperature curves.

²⁾ Thermal isolator is used if process connection temperature exceeds 85 °C (185 °F)

³⁾ Minimum voltage of 15 V DC is required for use at -40 °C (-40 °F)

⁴⁾ Not suitable for steam environments

Design: Probe	Rod version	Stilling well version	Cable version
Length	Min. 300 mm (12 inch), max. 5 000 mm (197 inch)	Min. 300 mm (12 inch), max. 5 000 mm (197 inch)	Min. 1 000 mm (40 inch), max. 25 000 mm (984 inch)
Sensor wetted parts	PFA, 316L stainless steel	PFA, 316L stainless steel	316L stainless steel or 316L stainless steel with PFA insulation
O-ring seal material	FKM or FFKM	FKM or FFKM	FKM or FFKM
Thermal isolator	Optional	Optional	Optional
Options	N/A	N/A	Mounting eye for PFA insulated cable version

SITRANS LC300

Characteristic curves

Pressure/temperature curve
 LC300 standard, extended rod and cable probes
 Threaded process connections
 (7ML5670, 7ML5671, 7ML5672 and 7ML5673)

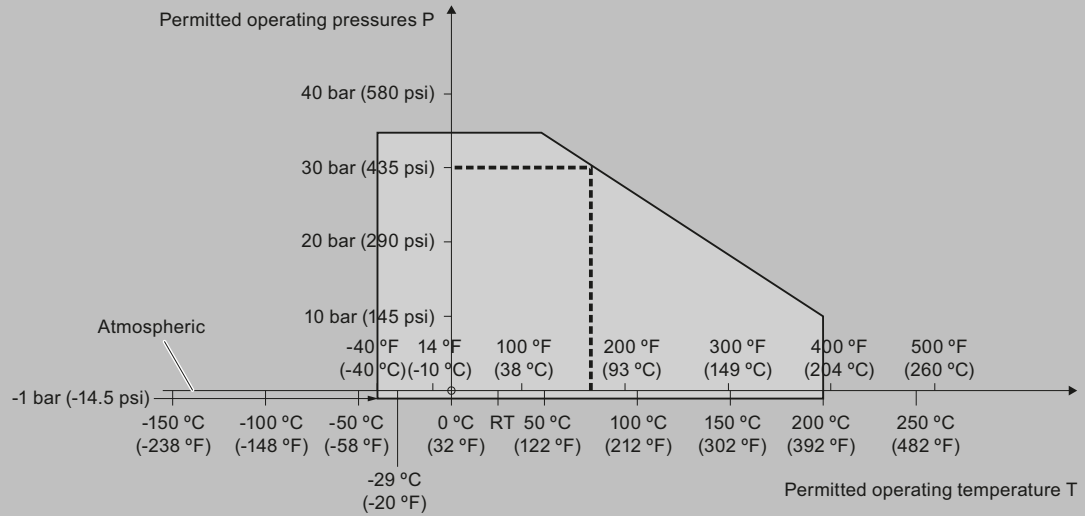

----- Example:
 Permitted operating pressure = 30 bar (435 psi) at 75 °C

SITRANS LC300 process pressure/temperature derating curves (7ML5670, 7ML5671, 7ML5672, and 7ML5673))

Characteristic curves (continued)

Pressure/temperature curve
 LC300 standard, extended rod and cable probes
 ASME flanged process connections
 (7ML5670, 7ML5671, 7ML5672 and 7ML5673)

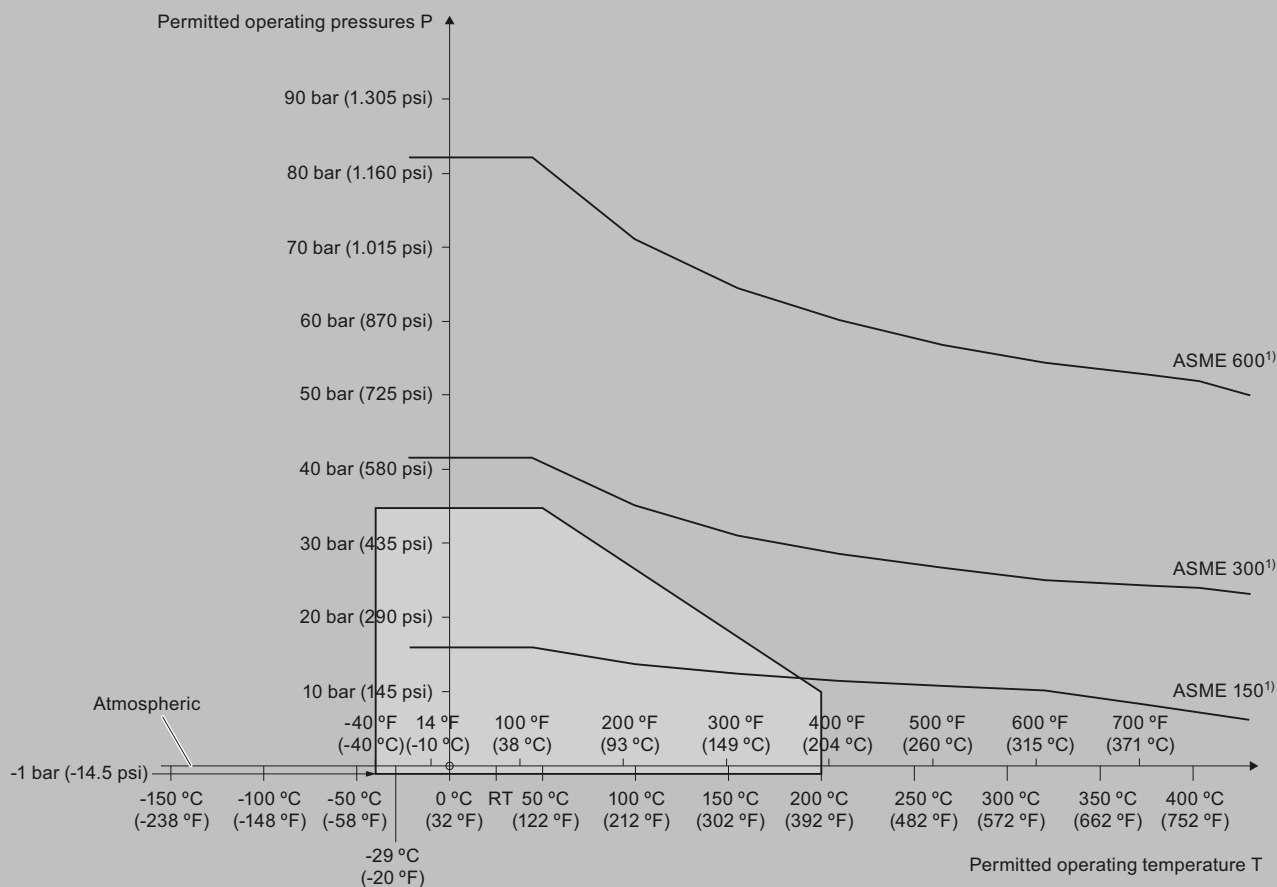

1) The curve denotes the minimum allowable flange class for the shaded area below.

SITRANS LC300 process pressure/temperature derating curves (7ML5670, 7ML5671, 7ML5672, and 7ML5673)

SITRANS LC300

Characteristic curves (continued)

Pressure/temperature curve
 LC300 standard, extended rod and cable probes
 EN flanged process connections
 (7ML5670, 7ML5671, 7ML5672 and 7ML5673)

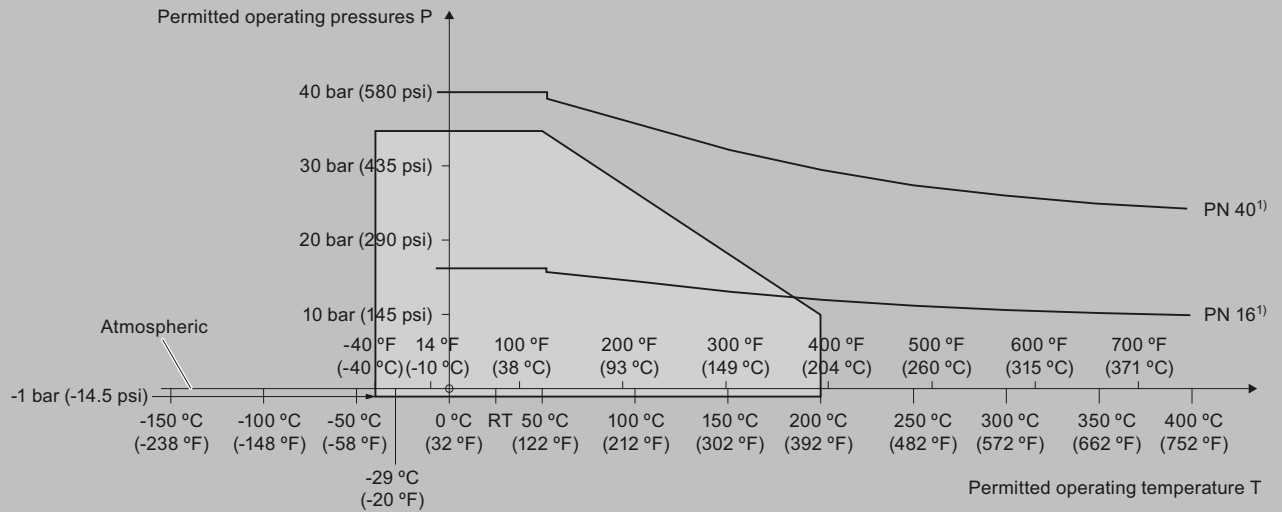

¹⁾ The curve denotes the minimum allowable flange class for the shaded area below.

SITRANS LC300 process pressure/temperature derating curves (7ML5670, 7ML5671, 7ML5672, and 7ML5673)

Dimensional drawings

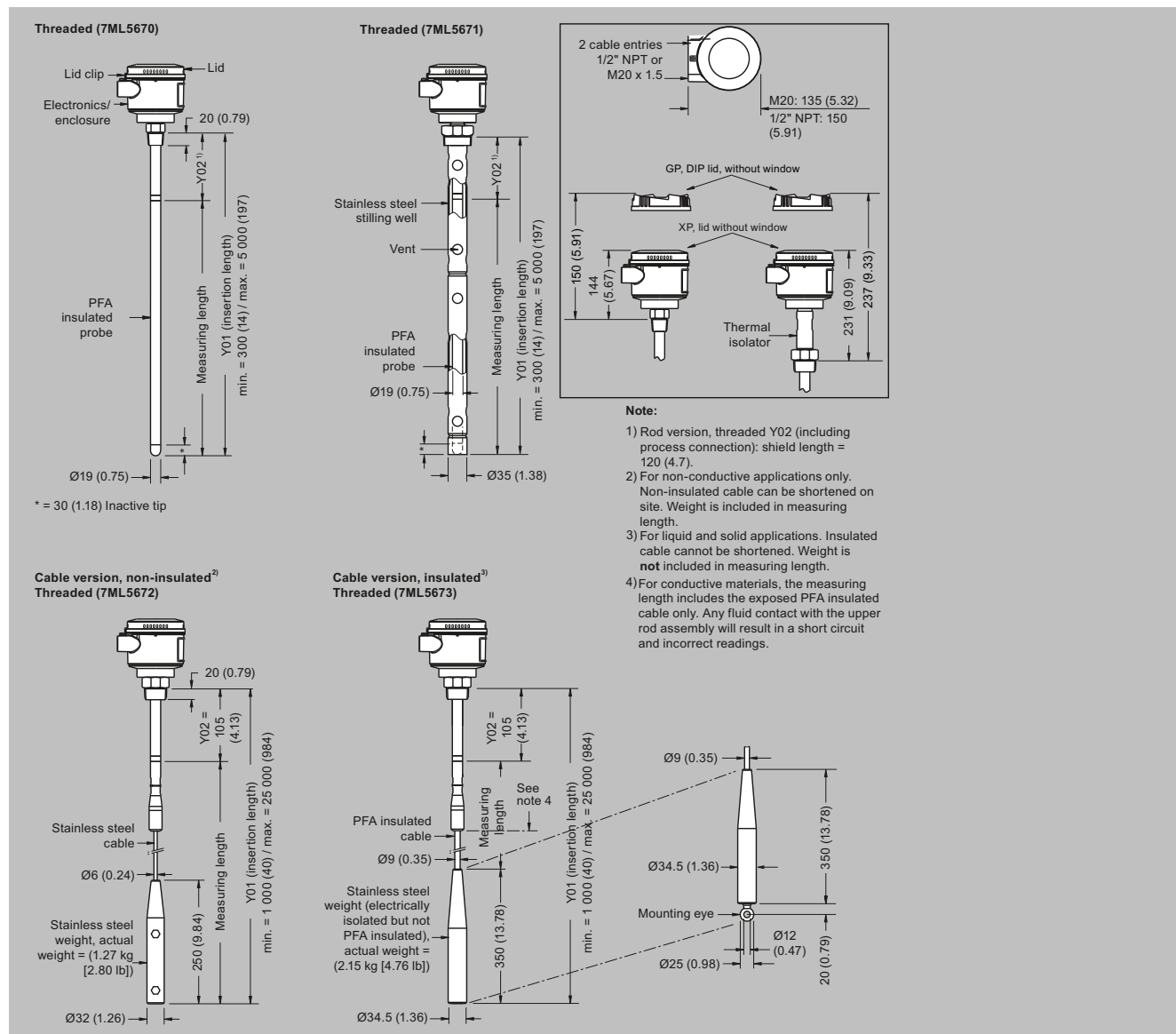

SITRANS LC300 threaded process connections, dimensions in mm (inch)

SITRANS LC300

Dimensional drawings (continued)

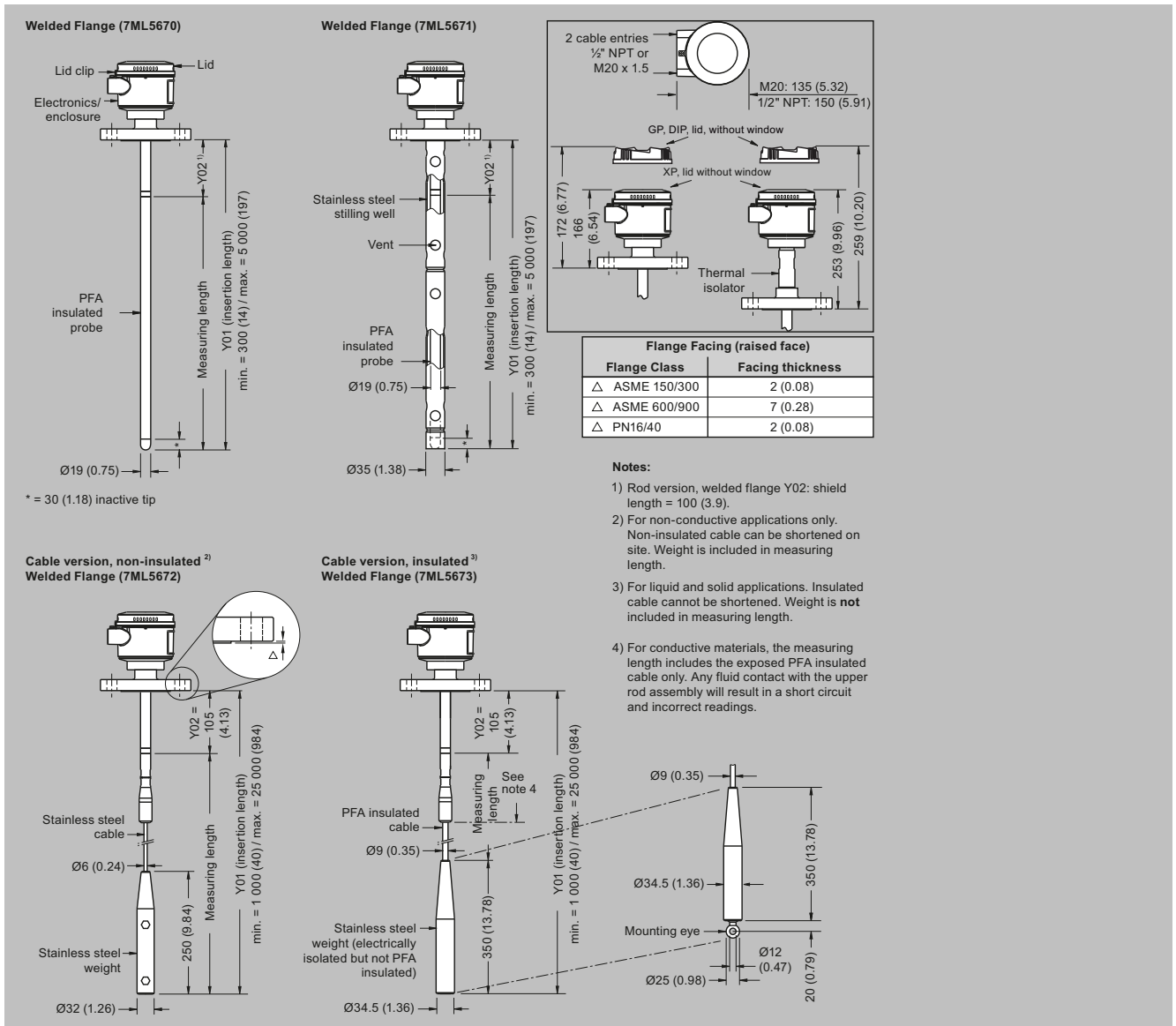

SITRANS LC300 flanged process connections, dimensions in mm (inch)

Circuit diagrams

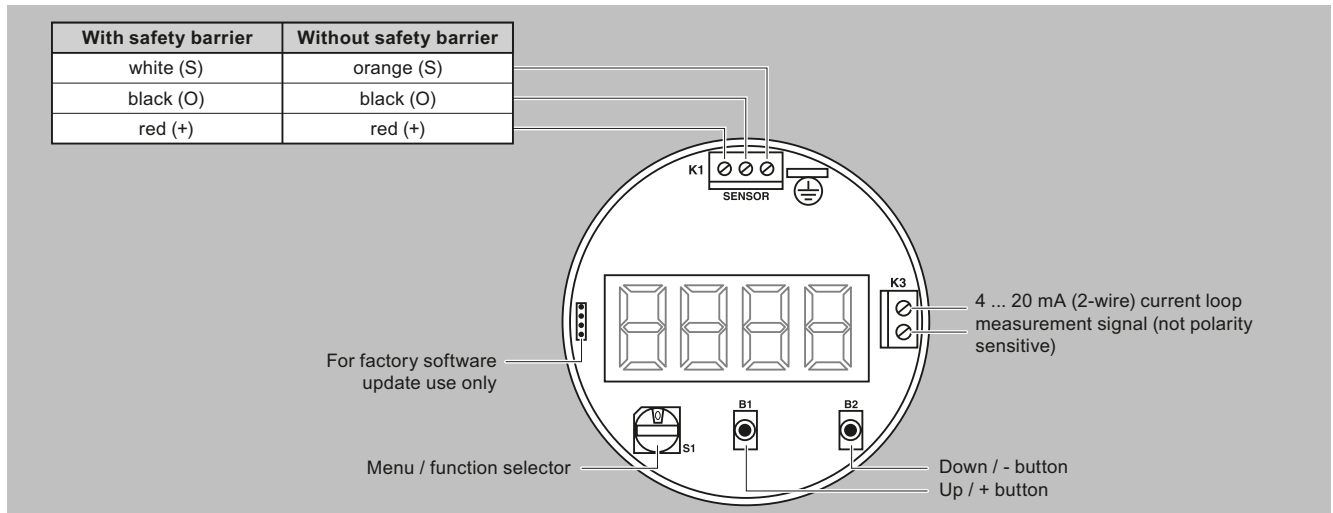

SITRANS LC300 connections